



## OWNER'S MANUAL

Models RCU-H11, RCU-H9, RCU-H7, RCU-H5, RCU-H3

DOMESTIC USE ONLY

Please read this document carefully before installing and/or using your vacuum cleaning system.

Model : \_\_\_\_\_ Serial Number : \_\_\_\_\_

Installation

Operating  
Instructions

Maintenance

Troubleshooting

Warranty  
Information

# IMPORTANT SAFETY INSTRUCTIONS

When using an electrical appliance, basic precautions should always be followed, including the following. Read all instructions before using this appliance.

## **WARNING** – To reduce the risk of fire, electric shock, or injury:

1. Do not leave appliance when plugged in. Unplug from outlet when not in use and before servicing.
2. Do not use outdoors or on wet surfaces.
3. Do not allow to be used as a toy. Close attention is necessary when used by or near children. This appliance is not intended for use by people (including children) with reduced physical, sensory or mental capabilities, or lack of experience and knowledge, unless they have been given supervision or instruction concerning the use of the appliance by a person responsible for their safety.
4. Use only as described in this manual. Use only manufacturer's recommended attachments.
5. Do not use with damaged cord or plug. If appliance is not working as it should, has been dropped, damaged, left outdoors, or dropped into water, return it to a service center.
6. Do not pull or carry by cord, use cord as a handle, close a door on cord, or pull cord around sharp edges or corners. Do not run appliance over cord. Keep cord away from heated surfaces.
7. Do not unplug by pulling on cord. To unplug, grasp the plug, not the cord.
8. Do not handle plug or appliance with wet hands.
9. Do not put any objects into openings. Do not use with any opening blocked; keep free of dust, lint, hair, and anything that may reduce air flow.
10. Keep hair, loose clothing, fingers, and all parts of body away from openings and moving parts.
11. Do not pick up anything that is burning or smoking, such as cigarettes, matches, or hot ashes.
12. Do not use without dust bag and/or filters in place.
13. Turn off all controls before unplugging.
14. Use extra care when cleaning on stairs.
15. Do not use to pick up flammable or combustible liquids such as gasoline or use in areas where they may be present.
16. Connect to a properly grounded outlet only. See Grounding Instructions.

## **SAVE THESE INSTRUCTIONS**

Preface.....	4
Schematic .....	4

## Installation

Unit Installation .....	5
Using the Right Air Intake.....	6
Utility Valve Installation .....	7
Dos & Don'ts .....	8
Muffler Installation.....	11
Electric Connections.....	11
Grounding Instructions .....	12
Low Voltage Connections .....	13

## Operating instructions

Hose Hook-Up & Inlets.....	14
Progressive Start .....	15
Automatic Stop .....	15
LED Indicator.....	15
Information Center.....	15

## Maintenance

Motor .....	16
Use with Bag.....	17
Use without Bag.....	18
Converting the Unit.....	19
Carbon Dust Filter.....	20

## Troubleshooting

General Information .....	21
Decrease in Suction Strength.....	22
Vacuum will not Start.....	24
Vacuum will not Stop.....	25

## Warranty Information

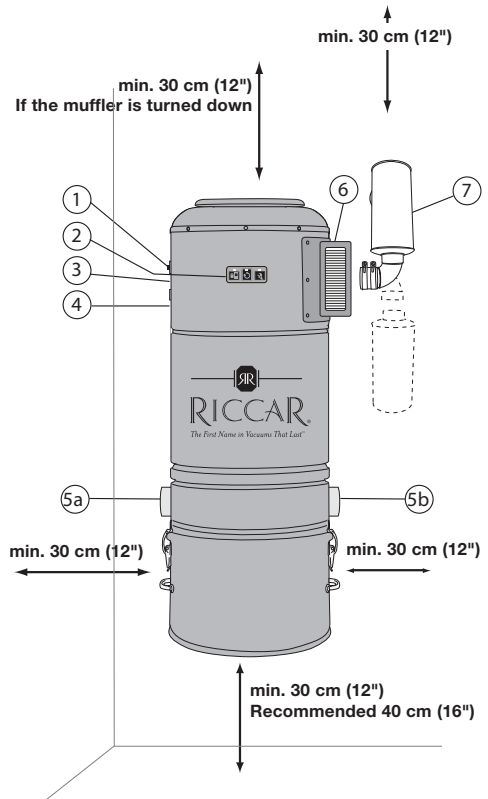
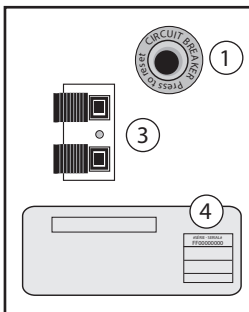
Limited Lifetime Warranty.....	26
--------------------------------	----

## Preface

Your new Riccar central vacuum system was designed and manufactured in Blainville, Quebec, by the largest central vacuum cleaner manufacturer in Canada, providing a high-quality, state-of-the-art product. Our extensive network of qualified professionals ensures first quality service near you. Contact us for the location of the Riccar authorized service center in your area.

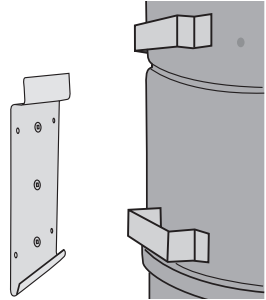
## Schematic

1. Circuit Breaker
2. Information Center (H9 & H11 models only)
3. Low Voltage Connectors
4. Serial Number
- 5a. Left Air Intake
- 5b. Right Air Intake  
(except H3)  
Seal the unused air intake with the provided cap.
6. Carbon Dust Filter (H9 & H11 (2x) only)
7. Muffler  
(2 mufflers on H11)



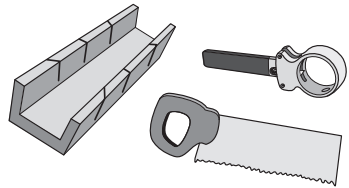
## Unit Installation

Using the mounting plate provided with your vacuum cleaner, secure the unit to the wall (**figure 1**), at a height allowing easy access for maintenance of the dirt receptacle and/or bags (see page 4).



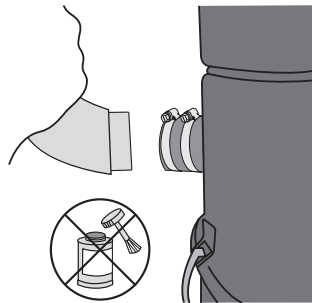
**figure 1**

The connections to the piping system will require some basic tools: a mitre box and small saw or a pipe cutter (**figure 2**). See pages 8 and 9 for general instructions pertaining to the preparation of PVC pipes. To simplify matters, installation kits, including necessary fittings, pipes, glue and wiring, as well as a detailed instructions booklet, are available from Riccar service centers.



**figure 2**

Contrary to all other connections in the piping system, do not glue the last fitting to your unit. Use the provided rubber seal and clamp collars to secure the last fitting to the air intake and obtain an air-tight fit (**figure 3**).



**figure 3**

## Using the Right Air Intake

(except H3 model)

To use the air intake located on the right side of the vacuum:

1. Using a flat screwdriver, loosen the clamp collars and remove the rubber coupling from the left air intake (**figure 4**).
2. Unlatch the two clips and remove the dust receptacle (see page 17, **figure 15**).
3. Remove the bag if needed for more convenience (see page 17).
4. Pull the bag adaptor out of the left air intake (**figure 5**).
5. Remove the cap on the right air intake (**figure 6**) and put it on the left air intake. Making sure that the tabs are aligned with the notches, push the cap in completely (**figure 7**).
6. From the inside of the vacuum, insert the bag adaptor into the right air intake, making sure that the embossed lines on the adaptor are aligned with the slots in the air intake (**figure 8**). Outside the vacuum, the end of the adaptor should come out of the air intake about  $\frac{3}{4}$ " (1.9 cm).
7. Put the rubber coupling on the right air intake and tighten the clamp collars using a flat screwdriver.
8. Put the bag and dust receptacle back in place and latch both clips (see page 17).

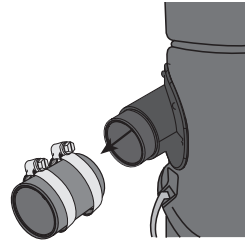


figure 4

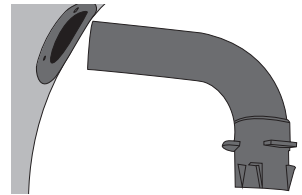


figure 5

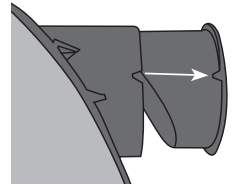


figure 6

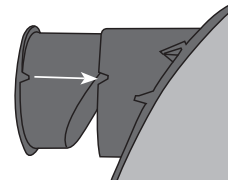


figure 7

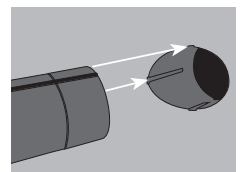
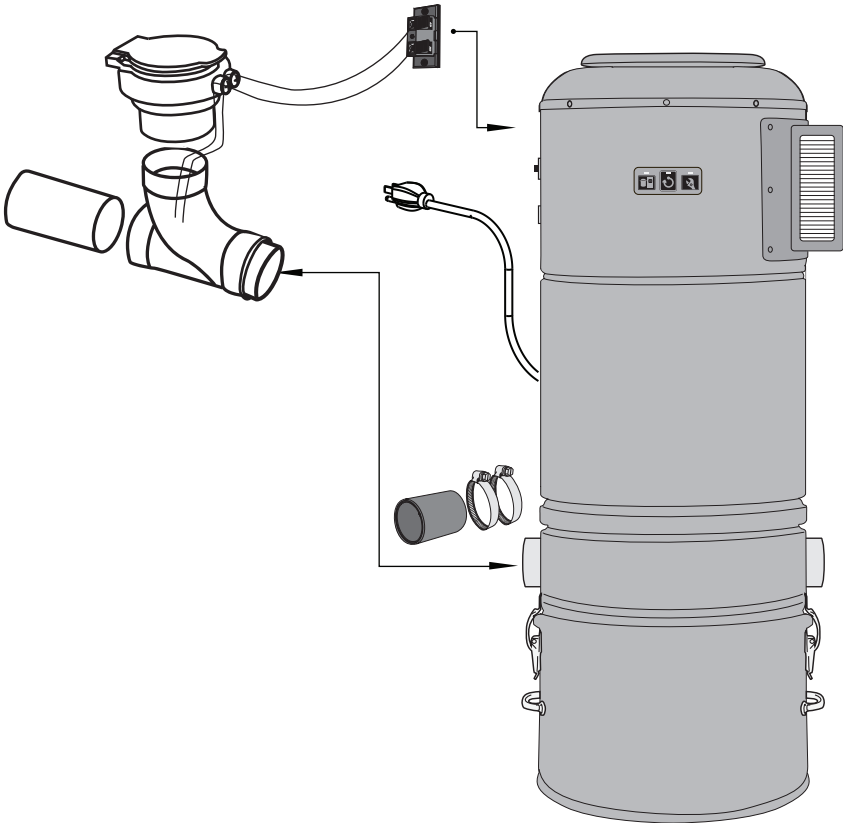


figure 8

## Utility Valve installation

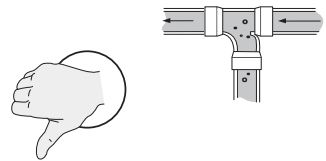
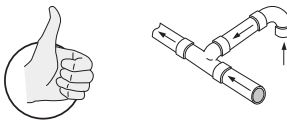
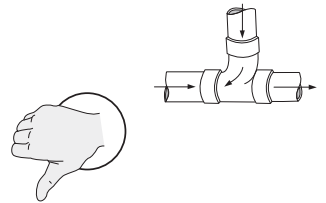
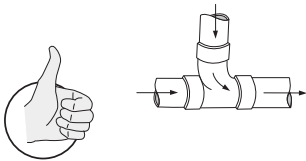
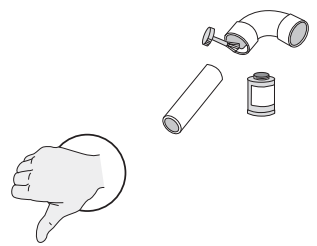
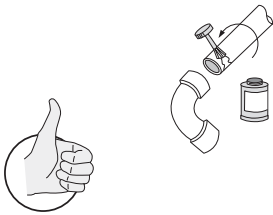
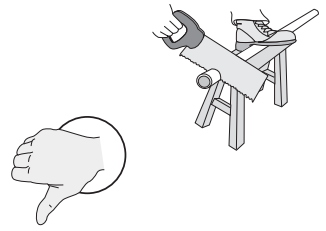
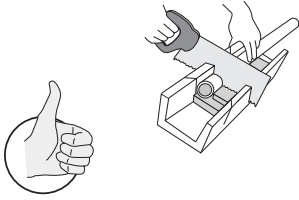
(H7, H9 & H11 models)

1. Secure the T-elbow on the air intake (see page 5, **figure 3**).
2. Install the utility valve on the T-elbow.
3. Connect the low voltage wiring (see pages 10 & 13).



# Dos & Don'ts

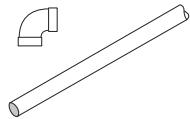
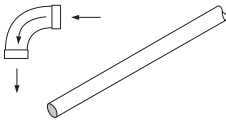
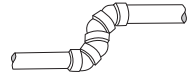
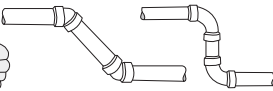
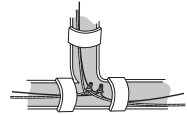
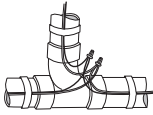
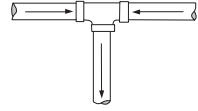
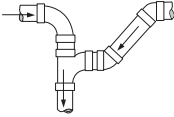
## Installing Conduits





# Dos & Don'ts

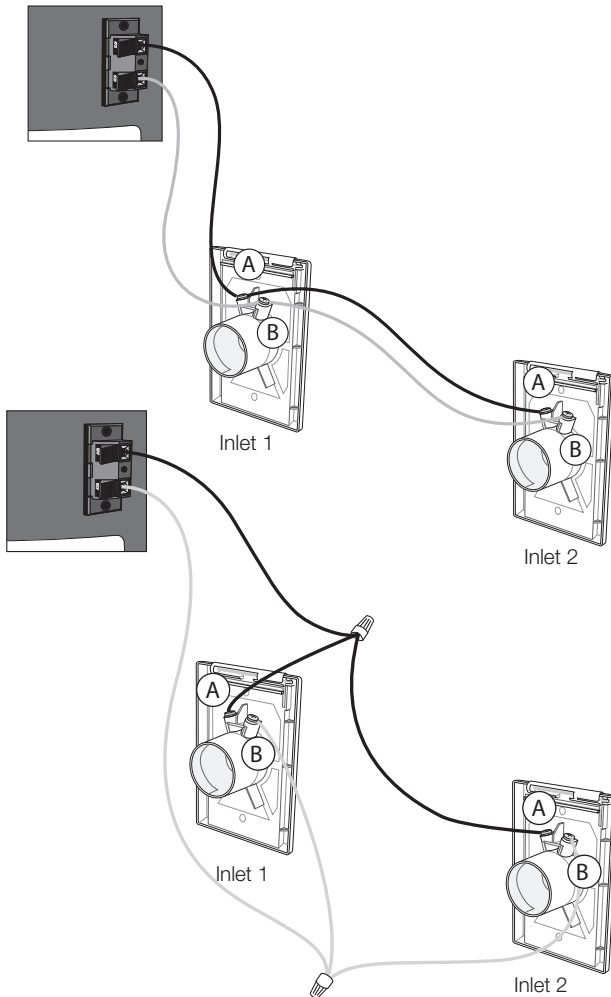
## Installing Conduits



# Dos & Don'ts

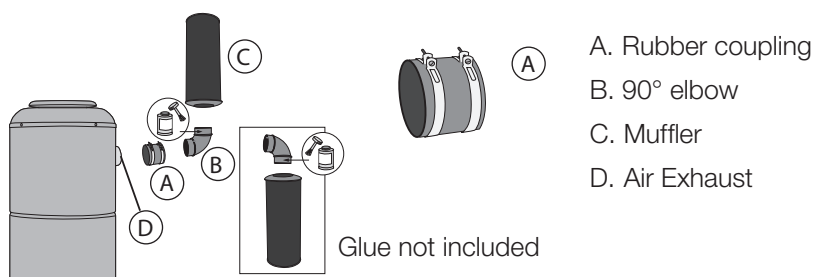
## Installing Inlets

When installing your vacuum inlets, we recommend that the principle of electric polarity be taken into account. Ensure that the wire connected onto contact A on inlet 1 is the same as that connected to contact A on inlet 2, and so on. Do not cross, reverse or interchange wires.



## Muffler Installation (Optional)

1. Insert the rubber coupling on the vacuum air exhausts.
2. Using a Phillips screwdriver, tighten the clamp collar to ensure adequate sealing.
3. Insert the 90° elbow into the rubber coupling and tighten, then clamp collar as per instructions in step 2.
4. Apply ABS glue to the 90° elbow and insert muffler.
5. For H11, repeat steps 1 to 4 to install second muffler turned down.



## Electric Connections

There should be an electric outlet within 1 meter (3 feet) of your central vacuum unit. Once the appliance is installed in a suitable location, connect your central unit to an electric outlet on an dedicated\* grounded circuit. Do not use extension cords or modify the length of your vacuum cleaner's power cord.

### Dedicated\* grounded circuit

- North America  
120V / 240V All models: 15A

Your central vacuum cleaner has a thermal safety device or a circuit breaker to protect against any over voltage or electrical defect. If that protection should fail, contact your authorized service center.

\*Please reserve a circuit breaker dedicated only to the connections for your central vacuum.

***If you find that installing your vacuum cleaner is too difficult, ask your service center to install it for you. When in doubt, it is better to have the work done by a professional and ensure that the unit is properly installed. Any installation that does not comply with the specified norms could alter or invalidate the warranty.***

## Grounding Instructions

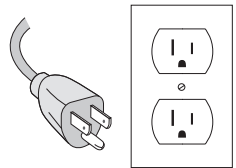
This appliance must be grounded. If it should malfunction or breakdown, grounding provides a path of least resistance for electric current to reduce the risk of electric shock. This appliance is equipped with a cord having an equipment-grounding conductor and grounding plug. The plug must be inserted into an appropriate outlet that is properly installed and grounded in accordance with all local codes and ordinances. No adaptor should be used with this appliance.

### WARNING

Improper connection of the equipment-grounding conductor can result in a risk of electric shock. Check with a qualified electrician or service person if you are in doubt as to whether the outlet is properly grounded. Do not modify the plug provided with the appliance – if it will not fit the outlet; have a proper outlet installed by a qualified electrician.

#### 120V Models

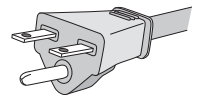
This appliance is for use on a nominal 120V circuit, and has a grounded plug (**figure 9**). Make sure that the appliance is connected to an outlet having the same configuration as the plug. No adaptor should be used with this appliance.



**figure 9**

#### 220V/240V Models (RCU-H11 only)

This appliance is for use on a circuit having a nominal rating more than 120 V and is factory-equipped with a specific cord and plug to permit connection to a proper electric circuit. Make sure that the appliance is connected to an outlet having the same configuration as the plug. No adaptor should be used with this appliance. If the appliance must be reconnected for use on a different type of electric circuit, the reconnections should be made by a qualified service personnel.



## Low Voltage Connections

Connect the low voltage wires to the low voltage inlet on your unit.

To do so:

1. Strip wires over 1 cm (1/2 inch) **(figure 10)**.
2. Gently press on the toggle to open the connector **(figure 11)**.
3. Insert stripped wire **(figure 12)**.
4. Release toggle to secure wire in connector **(figure 13)**.
5. Repeat for second wire.

To disconnect:

1. Gently press on the toggle to open the connector.
2. Remove low voltage wire from connector.

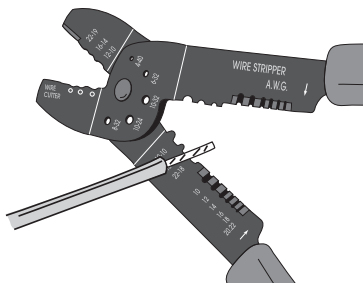


figure 10

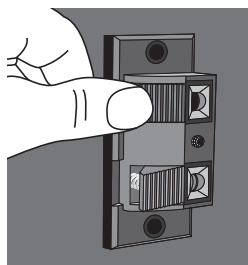


figure 11

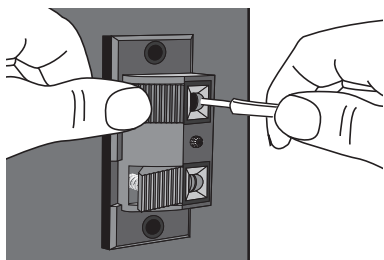


figure 12

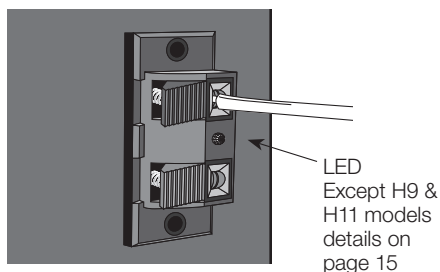


figure 13

## Hose Hook-Up & Inlets

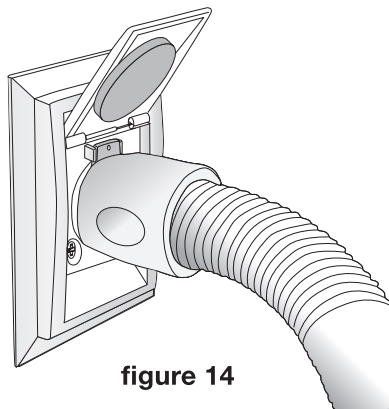
### Before operating your central vacuum...

Please verify that it is properly connected to the piping system, and to a grounded electrical outlet, and that the low voltage wires are connected to the unit (see pages 5 to 13). Then read the complete owner's manual and proceed with a quick verification of your unit's installation:

- Check filter and bag to be sure they are properly installed.
- Check rubber seals in each vacuum inlet.
- Plug the hose alternatively into each vacuum inlet, to ensure that each one works properly.
- While the hose is still plugged into one inlet and the system is operational, check other inlets for leaks.

To start your central vacuum, simply insert the hose in the vacuum inlet of your choice. Please ensure that the tab on the hose end is properly lined up with the slot in the inlet opening (**figure 14**). If your hose handle has an integrated on/off switch, simply slide the switch to the "on" position.

***Do not try to open another inlet while your system is in operation, as it may damage the inlet's rubber seal.***



**figure 14**

## Progressive Start

(H9 & H11)

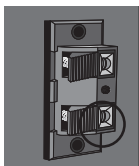
Each model is equipped with a special module allowing for a smooth and gradual start-up of the vacuum system to prolong motor durability.

## Automatic Stop

(H9 & H11)

In case you've forgotten to turn off your vacuum, or it's been turned on by mistake, your vacuum system will automatically shut off after 45 minutes to one hour of uninterrupted use. Simply restart the vacuum system with the switch on the hose handle.

## LED Indicator



**LED – On low voltage connector**

**Steady green** – indicates unit is connected to a power source

## Information Center

(H9 & H11 models)

Your central vacuum unit is equipped with an electronic timing device which will recommend proper maintenance of your vacuum system. These signals are only suggestions and do not indicate a problem with your vacuum system. They will not stop or hinder the use of the vacuum.

- ❶ Flashing LED - Empty dirt receptacle or change bag
- ❷ Press 1 second to stop the flashing LED
- ❸ Flashing LED - Have unit checked by service center



## Motor

Please note that Riccar motors do not require lubrication. Each motor contains two carbon brushes which will wear normally, and may eventually require replacement. For warranty purposes, this should be done by an authorized service center. Brush life is affected by the number of hours used, frequency of start-ups and shut-downs, humidity, altitude, and temperature. In order to avoid damage to the motor itself, brushes should be replaced before they are completely worn out. We therefore recommend that you have your unit and motors inspected by a service center every 5-6 years.

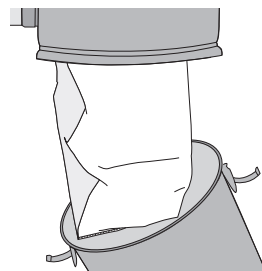


## Maintenance

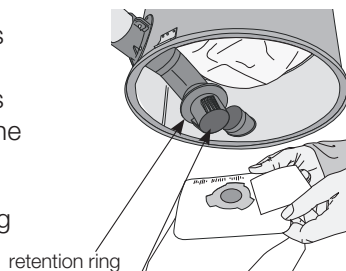
### For use with bag

Change the bag when the one in place is full. Frequency will depend on the use of the unit. For the H9 & H11 models, the information center will indicate when to change the bag. These indications are provided by an electronic timing board, only as a reference guide.

1. To access the bag, unlatch the two clips and remove the dust receptacle (**figure 15**).
2. Remove the used bag and seal bag opening (adhesive seal provided on each bag). Discard used bag.
3. Install the new bag, ensuring the tabs on the bag adaptor are aligned with the slots in the bag collar (**figure 16**).
4. Ensure adequate sealing by inserting bag as far as the retention ring (**figure 17-A**). Rotate bag 20° (**figure 17-B**) to ensure tabs on bag adaptor are no longer aligned with the slots in the bag collar.
5. Replace dust receptacle and seal by latching both clips.

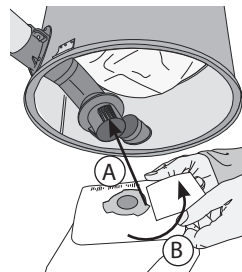


**figure 15**



**figure 16**

tabs on bag adaptor



**figure 17**

***Use only genuine Riccar replacement bags. Failure to do so could void the warranty on your vacuum unit.***

## Maintenance

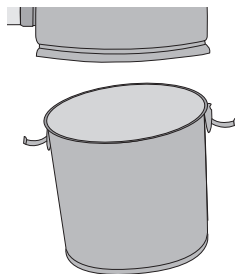


### For use without bag

We recommend you empty the dust receptacle and clean the permanent filter at least each season, depending on use of your central vacuum.

1. To empty the dust receptacle:

Disconnect the unit from the electric outlet. Unlatch the two clips, remove the receptacle (**figure 18**), and empty into an appropriate container.



**figure 18**

2. To clean the permanent filter (**figure 19**):

- Do not remove the filter
- Wrap the filter and the lower portion of the unit body within a large plastic bag. Hold it tightly around the unit with one hand.
- With your other hand, gently shake the filter.
- Wait a few seconds for the dust to settle before removing the plastic bag.



**figure 19**

3. Replace the dust receptacle and seal with the help of the two clips.

4. Reconnect the unit to the electric outlet.

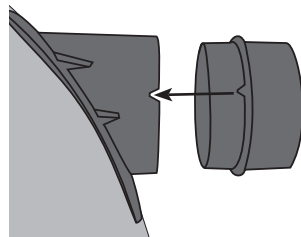
### Note:

**Should the filter become stained, or emit an unpleasant odor, it may be washed in cold water (without bleach). Rinse and dry well before replacing. Do not tumble dry.**

## Converting the Unit

Your Riccar central vacuum unit was designed for use with or without disposable bag. Though it is sold with a bag installed, it can easily be removed, and the unit modified for use without disposable bags.

1. Using a flat screwdriver, loosen the clamp collars and remove the rubber coupling from the air intake (see page 6, **figure 4**).
2. Unlatch the two clips and remove the dust receptacle (see page 17, **figure 15**).
3. Remove the bag (see page 17).
4. Pull the bag adaptor out of the air intake (see page 6, **figure 5**).
5. Put the other adaptor provided in the air intake and, making sure that the tabs are aligned with the notches, push it in completely (**figure 20**).
6. Put the rubber coupling back on the air intake and tighten the clamp collars using a flat screwdriver.
7. The vacuum unit is now ready for use without bag.



**figure 20**

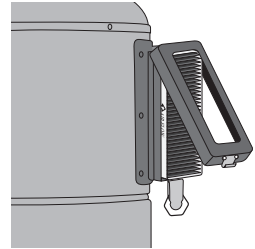
**Note: this procedure is reversible at any time. For instructions on installing the dust bag, please refer to page 17.**

## Carbon Dust Filter (H9 & H11 models)

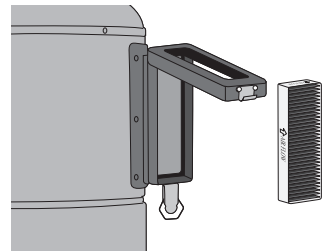
We recommend changing this filter after three bag replacements. The integrated monitor will indicate when to change the filter. These indications are provided by an electronic timing board, only as a reference guide.

To do so:

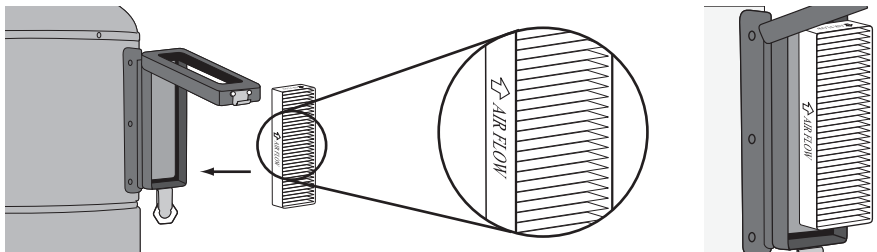
1. Unlatch the opening on the carbon filter case and gently flip it upward (**figure 21**).
2. Remove the used filter, and discard (**figure 22**).
3. Insert the new filter. When doing so, please ensure that the arrow printed on the filter itself points outwards (**figure 23**).
4. Close casing and latch.



**figure 21**



**figure 22**



**figure 23**

---

## General Information

If the vacuum unit does not work, check the fuse or breaker on the unit and/or in the electrical panel in your home, and replace any defective part(s) as deemed necessary. Please verify that the unit has been installed properly, according to the instructions in this manual.

Your vacuum cleaning system is designed to collect everyday dry matter (dust). It is approved by authorized testing agencies for dry use only. Do not use on wet surfaces.

Should you accidentally vacuum liquids, immediately unplug the unit from the electric outlet, then empty and wipe the dust receptical with a dry cloth. Then operate the system from the vacuum inlet through which you vacuumed the liquid, in order to eliminate all moisture in the piping system.

We strongly recommend against vacuuming abrasive materials such as cement, plaster and gyproc dust. This fine dust could work its way into the motor, causing considerable damage. Should you do so inadvertently, immediately clean the filters and, as a precautionary measure, contact your authorized service center to determine the extent of the damage to the unit.

***Remember that in order for your warranty to remain valid, maintenance of the motor and repairs to the unit itself must be carried out by an authorized service center using original Riccar parts.***

## Troubleshooting

Problem	Possible cause	Corrective action
<b>Decrease in suction strength</b>	Dirt receptical / Bag is full	Empty dirt receptical / change bag (see page 17 to 19).
	Dirt receptical is not properly attached	Check clamps holding dirt receptical, to make sure they are tight and dirt receptical is aligned.
	Open vacuum inlet	Close all vacuum inlets not in use.
	Exhaust line is clogged	Verify that no object is blocking the exhaust.
	Blocked hose	Plug the handle end of the hose into the suction inlet, thus reversing the suction in the hose. Cover the gap around the handle, to ensure suitable suction strength, and ensure contact with inlet contacts to start the unit. This should clear the hose.

# Troubleshooting

Problem	Possible cause	Corrective action
<p><b>Decrease in suction strength</b></p>	<p>Obstruction in the piping system</p>	<p>Loosen the clamp collars around the air intake connector, to free the central vacuum unit from the piping system (see figure 3 on page 5). Start the unit by plugging the hose into a vacuum inlet. By placing your extended hand over the air intake opening on the unit, check the suction strength on the unit itself. If suction strength is normal, the obstruction is in the piping system. If suction strength is diminished or completely absent, have the unit checked by an authorized service center.</p>

## Troubleshooting

Problem	Possible cause	Corrective action
<b>Vacuum will not start</b>	The electrical power is not connected properly	Ensure that the power cord is plugged into a dedicated grounded electrical outlet, according to specifications on pages 11 and 12.
	Low voltage wire not connected properly	Verify the low voltage wires, make sure they are properly inserted into the low voltage inlet, as per instructions on page 13.
	Faulty vacuum inlet	Start the vacuum unit from other inlets in your home, to identify the defective inlet.
	Faulty switch	Push the switch on the power unit to the on position. If the system starts, the problem lies within the low voltage wiring.
	Unit circuit breaker is off	Press the reset button to reset the unit circuit breaker. If unit restarts and automatically shuts off shortly after, contact an authorized service center.
	In-house circuit breaker is off	Reset the circuit breaker in your electrical panel. Verify that your central vacuum unit is connected on a dedicated grounded circuit (see pages 11 and 12).
	Defective on/off hose	Turn the hose 1/4 turn in the vacuum inlet. If unit starts, have the vacuum hose checked by a certified service center.



## Troubleshooting

Problem	Possible cause	Corrective action
<b>Vacuum will not stop</b>	Hose improperly inserted into vacuum inlet	Ensure that the hose end is properly inserted into the vacuum inlet. The tab on the hose end should line up with the slot in the inlet opening. (See page 14).
	Defective on/off hose	If the hose is properly placed in the vacuum inlet, and the unit continues running despite the fact that the hose switch is in the "off" position, have the hose checked by a service center.
	Low voltage wire not connected properly	While vacuum is on, unplug low voltage wires from unit. If vacuum stops, there's a faulty low voltage wire. Contact your installer or authorized service center.

If none of these suggestions restore suction strength, contact your authorized service center.

To locate your nearest Riccar Retailer, visit [www.riccar.com](http://www.riccar.com).

---

## Limited Lifetime Warranty

### WHAT IS COVERED / HOW LONG COVERAGE LASTS:

All permanently installed components of a Riccar central system are warranted to be free of defects in material and workmanship under normal use to the original purchaser at the original installation address. Motor and electrical components are warranted for ten (10) years.

All Riccar central system accessories are warranted to be free from defects in material and workmanship under normal use for three (3) years from the date of original consumer purchase.

In the event of a defect in permanently installed components of a Riccar central system, an authorized Riccar retailer should be contacted. The retailer will repair or replace (at our option) any defective part or parts at your location at no labor cost for a period of three (3) years. Thereafter, repaired or replacement (at our option) part or parts will be provided to you for items under warranty.

### WHAT IS NOT COVERED:

- Damage to the central vacuum which occurs from neglect, abuse, alterations, accident, misuse or improper maintenance.
- This warranty does not extend to any power nozzle accessory kit or accessories used in conjunction with this power unit. Riccar power nozzle accessory kits are covered under a separate warranty.

### WHAT RICCAR WILL DO:

This warranty provides, at no cost to you, all labor and parts to keep this central vacuum power unit in correct operating condition during the warranted period.

---

**HOW TO GET SERVICE:**

Warranty service can only be obtained by contacting an Authorized Riccar Retailer. A proof-of-purchase and product serial number will be required before service is rendered. To locate your nearest Riccar Retailer, please call 1-888-6-Riccar or visit the Riccar website at [www.riccar.com](http://www.riccar.com).

THIS WARRANTY IS EXCLUSIVE AND IN LIEU OF ANY AND ALL OTHER WARRANTIES WHETHER WRITTEN, ORAL, EXPRESSED OR IMPLIED, (INCLUDING ANY WARRANTY OF MERCHANTABILITY OR FITNESS FOR A PARTICULAR PURPOSE). THIS WARRANTY DISCLAIMS LIABILITY FOR INCIDENTAL, OR CONSEQUENTIAL DAMAGES.

**HOW STATE LAW APPLIES:**

This warranty gives you specific legal rights, and you may also have other rights which vary from state to state.

Register your warranty online at  
[www.riccar.com](http://www.riccar.com).



[www.riccar.com](http://www.riccar.com)  
1-888-6-RICCAR

